





DENT DE DÉROCTAGE

TS0-S / TS1-S / TS2-S / TS3-S

La DENT DE DÉROCTAGE trouve son emploi dans les travaux en terrain rocheux.

CARACTÉRISTIQUES TECHNIQUES MACHINE				
MODULE	0	1	2	3
POIDS MACHINE MINI-MAXI	0,5 t – 2 t	2 t – 3,5 t	3,5 t – 5,5 t	5,5 t – 7,5 t
EFFORT DE CAVAGE MAXI	19 kN	28 kN	38,5 kN	56 kN
COUPLE MAXI	10 mkN	21 mkN	35 mkN	56 mkN

CARACTÉRISTIQUES TECHNIQUES

	TS0-S	TS1-S	TS2-S	TS3-S
RAYON (A)	610 mm	748 mm	900 mm	923 mm
ÉPAISSEUR DENT	40 mm	60 mm	60 mm	80 mm
POIDS	25 kg	50 kg	80 kg	113 kg







Le produit représenté est un exemple de produit générique. Il peut varier en fonction de la demande du client. Les caractéristiques techniques peuvent évoluer en fonction de la configuration de l'équipement du godet. Ce document ne peut être copié, ni reproduit, ni transmis sous aucune autre forme à une tierce personne sans autorisation préalable écrite d'ACB PUME.

« RIPPER » TOOTH

TS0-S / TS1-S / TS2-S / TS3-S

The RIPPER TOOTH is useful for all works in rocky soils.

MACHINE TECHNICAL DATA				
MODULE	0	1	2	3
MACHINE WEIGHT RANGE	0,5 t – 2 t	2 t – 3,5 t	3,5 t – 5,5 t	5,5 t – 7,5 t
BREAK OUT FORCE	19 kN	28 kN	38,5 kN	56 kN
MAX. EXCAVATING TORQUE	10 mkN	21 mkN	35 mkN	56 mkN

TECHNICAL DATA

	TS0-S	TS1-S	TS2-S	TS3-S
RADIUS (A)	610 mm	748 mm	900 mm	923 mm
CORE THICKNESS	40 mm	60 mm	60 mm	80 mm
WEIGHT	25 kg	50 kg	80 kg	113 kg







The displayed product is a generic product. It may be customized to meet the customer's requests. The technical data may evolve with the specifications and the bucket features. No part of this document may be copied, or reproduced, or transmitted in any forms or any means to other third person, without the prior written allowance of ACB PUME.



DENT DE DÉROCTAGE

TS0-S / TS1-S / TS2-S / TS3-S

La DENT DE DÉROCTAGE trouve son emploi dans les travaux en terrain rocheux.

CARACTÉRISTIQUES TECHNIQUES MACHINE				
MODULE	0	1	2	3
POIDS MACHINE MINI-MAXI	0,5 t – 2 t	2 t – 3,5 t	3,5 t – 5,5 t	5,5 t – 7,5 t
EFFORT DE CAVAGE MAXI	19 kN	28 kN	38,5 kN	56 kN
COUPLE MAXI	10 mkN	21 mkN	35 mkN	56 mkN

CARACTÉRISTIQUES TECHNIQUES

	TS0-S	TS1-S	TS2-S	TS3-S
RAYON (A)	24 po	29 po	35 po	36 po
ÉPAISSEUR DENT	1,6 po	2,4 po	2,4 po	3,1 po
POIDS	55 lb	110 lb	176 lb	248 lb

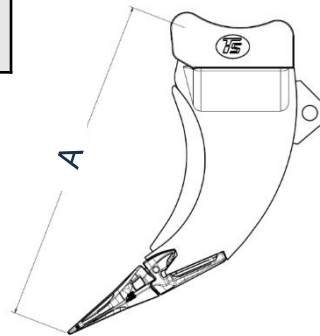





Le produit représenté est un exemple de produit générique. Il peut varier en fonction de la demande du client. Les caractéristiques techniques peuvent évoluer en fonction de la configuration de l'équipement du godet. Ce document ne peut être copié, ni reproduit, ni transmis sous aucune autre forme à une tierce personne sans autorisation préalable écrite d'ACB PUME.



« RIPPER » TOOTH

TS0-S / TS1-S / TS2-S / TS3-S

The RIPPER TOOTH is useful for all works in rocky soils.

MACHINE TECHNICAL DATA				
MODULE	0	1	2	3
MACHINE WEIGHT RANGE	0,5 t – 2 t	2 t – 3,5 t	3,5 t – 5,5 t	5,5 t – 7,5 t
BREAK OUT FORCE	19 kN	28 kN	38,5 kN	56 kN
MAX. EXCAVATING TORQUE	10 mkN	21 mkN	35 mkN	56 mkN

TECHNICAL DATA

	TS0-S	TS1-S	TS2-S	TS3-S
RADIUS (A)	24 inches	29 inches	35 inches	36 inches
CORE THICKNESS	1,6 inches	2,4 inches	2,4 inches	3,1 inches
WEIGHT	55 lb	110 lb	176 lb	248 lb

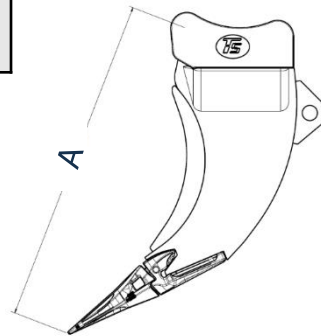

The displayed product is a generic product. It may be customized to meet the customer's requests. The technical data may evolve with the specifications and the bucket features. No part of this document may be copied, or reproduced, or transmitted in any forms or any means to other third person, without the prior written allowance of ACB PUME.









AUFREISSZAHN

TS0-S / TS1-S / TS2-S / TS3-S

Der AUFREISSZAHN ist für Felsarbeit geeignet.

TECHNISCHE DATEN DER MASCHINE				
MODUL	0	1	2	3
GEWICHT DER MASCHINE: MIN-MAX	0,5 t – 2 t	2 t – 3,5 t	3,5 t – 5,5 t	5,5 t – 7,5 t
LOSBRECHKRAFT	19 kN	28 kN	38,5 kN	56 kN
MAXIMALES AUSBRECHMOMENT	10 mkN	21 mkN	35 mkN	56 mkN

TECHNISCHE DATEN

	TS0-S	TS1-S	TS2-S	TS3-S
RADIUS (A)	610 mm	748 mm	900 mm	923 mm
HAUPT BLECHDICKE	40 mm	60 mm	60 mm	80 mm
GEWICHT	25 kg	50 kg	80 kg	113 kg

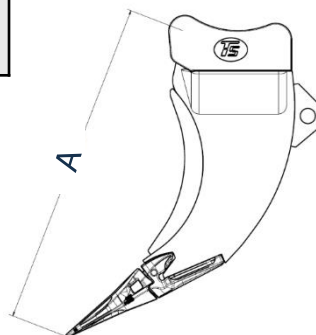

Das dargestellte Produkt ist ein generisches Produkt. Diese Produkt kann nach Kundenwunsch angepasst werden. Die technische Daten können je nach Ausstattung verändern werden. Dieses Dokument oder Teil aus diesem Dokument darf in irgend einer Form kopiert, reproduziert, oder eines Drittens übermittelt werden, ohne schriftliche Genehmigung von ACB PUME.

